

# MAGNASPHERE MSS -XXS & -K SERIES INSTALLATION INSTRUCTIONS: Surface Mount Contacts

## Required Tools and Components

### Provided by Manufacturer (per module set)

- 1 MSS switch module
- 1 MSS magnet module

### Provided by Installer

- Hand Tools
- Circuit Tester
- Fasteners

## MSS -XXS, -K SERIES

## SECURITY

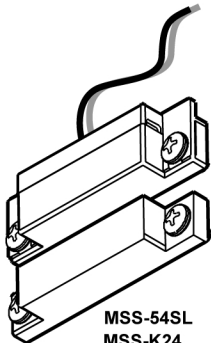

MSS-54SL  
MSS-K24  
MSS-K24S

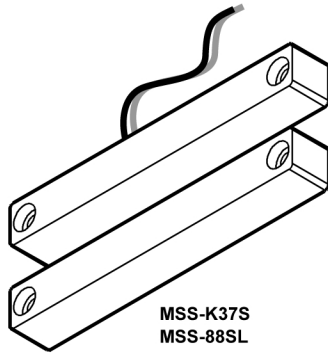

MSS-K37S  
MSS-88SL

## Specifications

**Max Current:** 0.25 A Resistive

**Max Voltage:** 30 VDC

**Max Power:** .25 W Resistive

The Magnasphere MSS-Concealed series is intended to be connected to a UL Listed compatible control panel for US applications and a ULC Listed compatible control panel for Canadian applications.

## NOMENCLATURE GUIDE

Surface Mount

MSS - # # S X

Size Class

12" Wire Leads (default, if blank),  
Terminals, 18" Armored Leads

or

MSS - K # # X

K = See Specification for

this distinct model

CONTACT STATE SHOWN WITH MAGNET IN PLACE

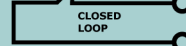

Length

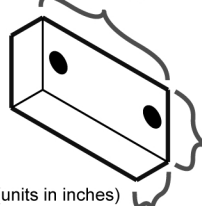

(units in inches)

Model

- MSS-54SL
- MSS-K24
- MSS-K24S
- MSS-K37S
- MSS-106S
- MSS-88SL

Max Gap

Length

Width

Height

Conductor

Model	Max Gap	Length	Width	Height	Conductor
MSS-54SL	.38	2.50	.50	.50	J
MSS-K24	.38	2.50	.50	.50	T
MSS-K24S	.38	2.50	.50	.50	J
MSS-K37S	.38	4.00	.50	.50	J
MSS-106S	.38	4.00	.50	.50	J
MSS-88SL	.38	4.00	.50	.50	J

Width

Conductor/Connection Key: L = 12" Leads, J = 12" Leads with Jacket, T = Screw Terminals, A = 18" Armored Leads

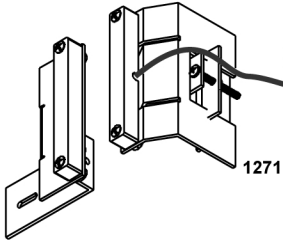

\* MSS-106S = MSS K37S fastened to a rail-mount bracket (P/N 1271) for use with overhead doors

## Installation Plan & Switch Orientation

The MSS -XXS/-K should be mounted close to the latch side of the door for optimal performance; Up to 15" (38cm) from the doorknob/door-latch edge is recommended in order to meet UL 681 requirements: contact shall be installed so door cannot be opened more than 2 inches without causing an alarm. See table for operating gaps. Ensure that the modules are well aligned. Before drilling, a careful layout of the site is recommended in order to achieve module alignment and secure routing of wires. Magnasphere uses rare-earth magnet materials which do not require isolation from steel surfaces. (Spacers may be needed only for alignment.)

Test and wire the switch. Magnasphere contacts have a directional, restricted sense zone for enhanced security. Check that the installation is properly oriented, bringing the magnet to rest within the contact's secure sense zone.

Fasten the switch modules to the frame and door. Test the operation of the installed switch.

Note: some models have multiple wire egresses and multiple mounting hole sets. One pair of fasteners per module is sufficient.

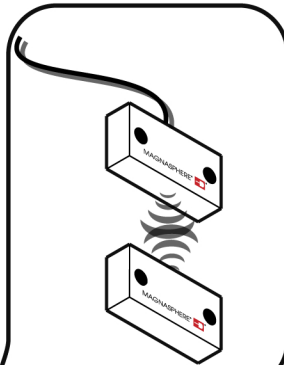

Closed-Loop Contact

Check your alarm panel's documentation for settings

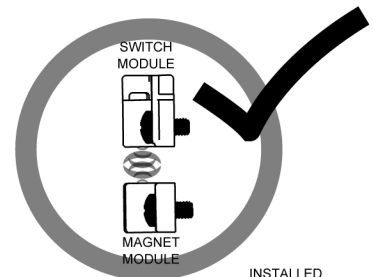
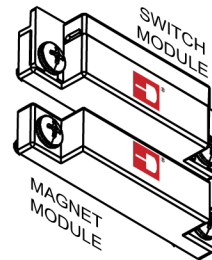
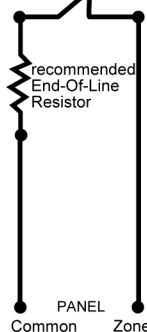

INSTALLED SIDE VIEWS

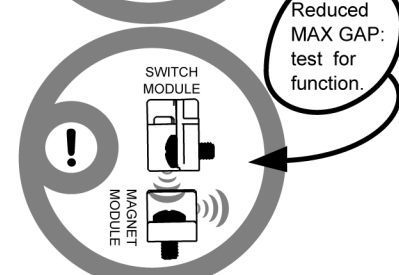
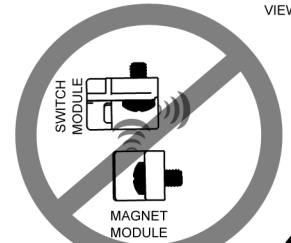

Reduced MAX GAP: test for function.

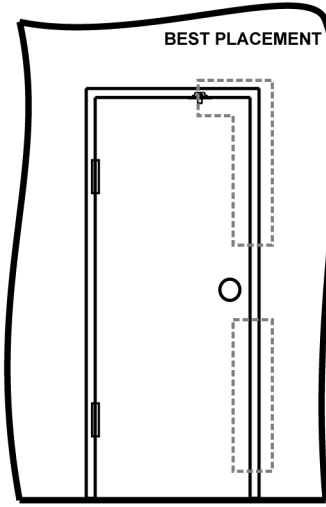

Models with "-RS#", "-RP#", or "-RS#P#" suffix have embedded End Of Line resistor/s of # value in kilo-Ohms.

