

MAGNASPHERE HSS INSTALLATION INSTRUCTIONS: All Models of (L2S & L2D) 000-FIRE Series



CAUTION: MAGNASPHERE MAGNET MODULES AND ANTI-REMOVAL MAGNETS ARE EXTREMELY POWERFUL: TAKE PRECAUTIONS TO AVOID THE MAGNETIC ATTRACTION OF SHARP TOOLS AND TO AVOID INJURY FROM THE PINCHING FORCE BETWEEN THE MAGNET AND FERROUS METALS OR OTHER MAGNETS.

Attention: modules à aimants Magnasphere et anti-enlèvement aimants sont très puissants: prendre des précautions pour éviter l'attraction magnétique d'outils tranchants et à éviter les blessures de la force de pincement entre l'aimant et les métaux ferreux ou d'autres aimants.

Required Tools and Components

Provided by Manufacturer (per module set)

- 1 HSS switch module
- 1 HSS magnet module
- 7 switch & magnet module self-tapping screws (#10-32 x 2")
- 2 self-tapping screws (#6, 1" long)
- 1 HSS switch module template
- 1 HSS magnet module template
- 1 anti-rotational threaded stud (set screw)
- 2 1/16" metal spacer plates
- 1 Removal-Tamper magnet
- 2 Removal-Tamper caps

Provided by Installer

- Power drill
- Drills bits: #35, #21, 3/16"
- Phillips screwdriver or a Phillips bit for use in the drill/bit-driver
- Rule (or any linear measuring instrument)
- A center punch (& hammer) for more accurate hole locations may be used
- A pilot drill bit for screws (3/32" or smaller) may be used
- Additional spacers as needed

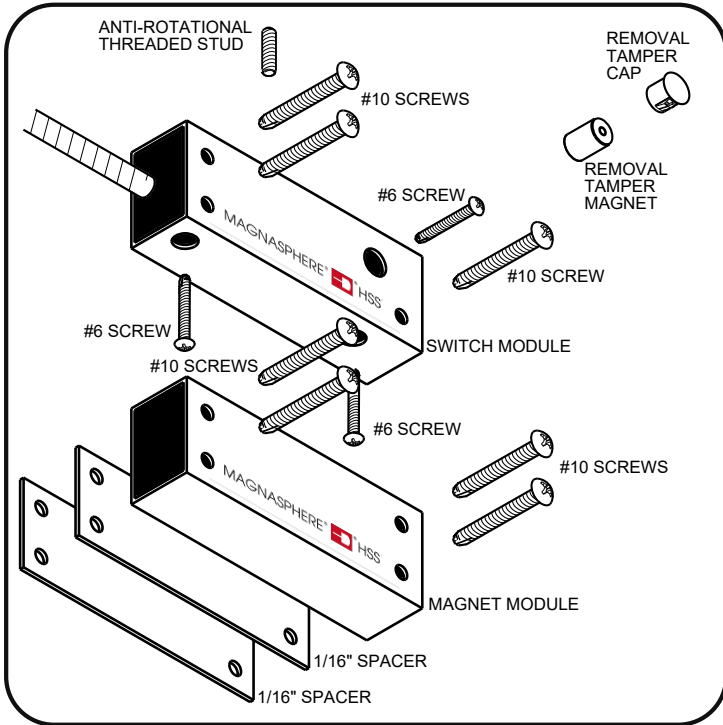

Specifications

Max Current: 0.25 A Resistive

Max Voltage: 30 VDC

Max Power: .25 W Resistive

Suitable for outdoor use.

The L2D and L2S series is intended to be connected to a UL Listed compatible control panel for US applications and a ULC Listed compatible control panel for Canadian applications. **UL Classified Miscellaneous Fire Door Accessory: ANSI/UL 10C Listed, 20 min rated**

resistors are optional

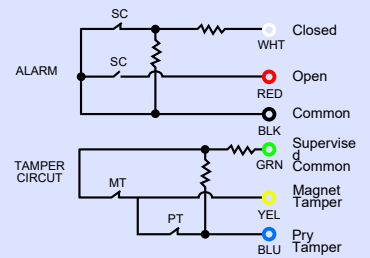

L2S-0##-FIRE Series

resistors are optional

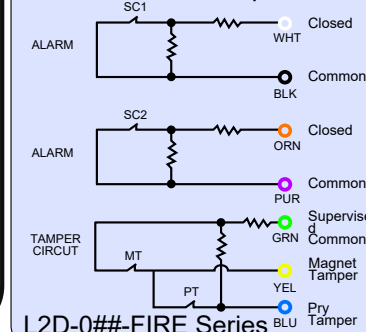

L2D-0##-FIRE Series

Test the Magnet-Tamper circuit here with a powerful magnet

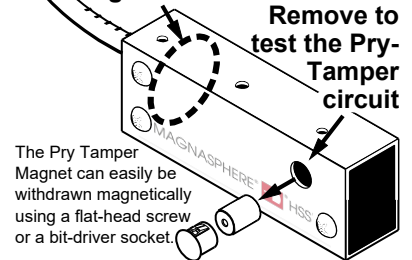

Installation Plan: Face-mounted HSS for an in-swinging (ingress) door

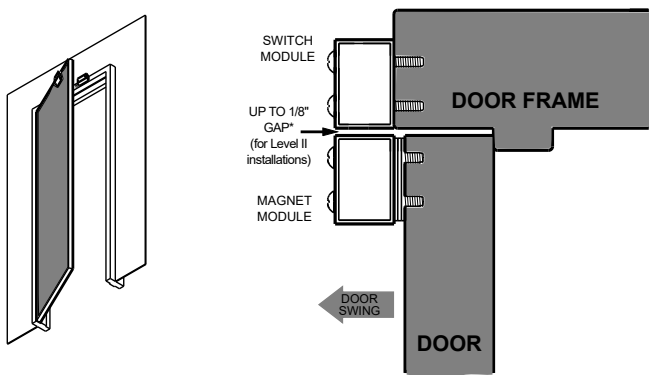

Plan to mount the switch module to the door frame, close to the door/frame gap and without door-swing interference. The magnet module must be mounted directly below the switch. Spacers may be used to attain sufficient alignment. Recommended placement for the set is 8 inches from the latch side of the door**, at the top. Provided templates may assist locating holes. ***A gap up to 1/8" is required for compliance with UL634 Level 2, C634 high security standard.** For non High Security installations: up to 3/16" gap.

Installation Plan: Top-surface-mounted HSS for an out-swinging (egress) door

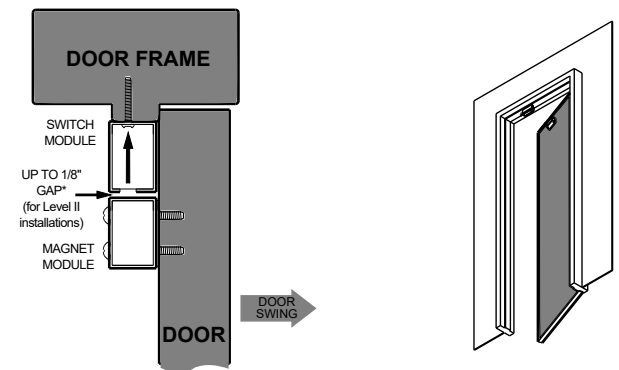

Plan to mount the switch module to the door stop, close to the door but without door-closure interference. The magnet module must be mounted directly below the switch. Spacers may be used to attain sufficient alignment. Recommended placement for the set is 8 inches from the latch side of the door**, at the top. Provided templates may assist locating holes. ***A gap up to 1/8" is required for compliance with UL634 Level 2, C634 high security standard.** For non High Security installations: up to 3/16" gap.

(continued) ingress door instructions:

A clearance hole for the anti-rotational screw must be drilled into the door frame before mounting the switch module; its position is given on the templates. For anti-tamper purposes, the switch module has two sites for an anti-rotational threaded stud; only one site will be used depending on which installation plan is chosen. Thread the screw into hole until about 1/4" of the screw remains outside the module.

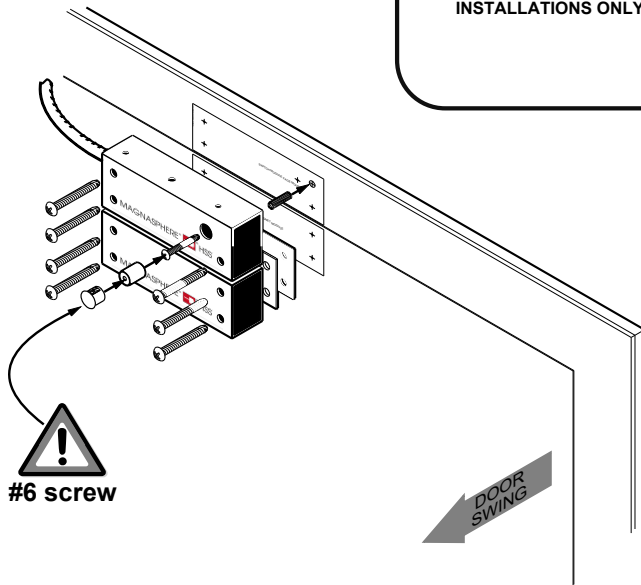
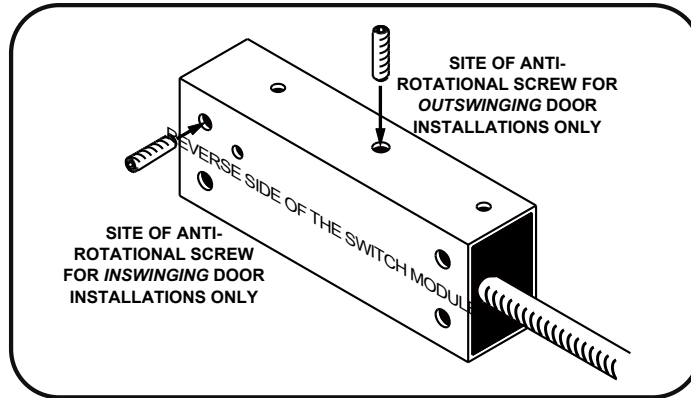

Mark & pilot-drill all hole locations. The single clearance hole for the anti-rotational screw must now be drilled to 3/16" or 7/32" diameter. Drill the 3 mounting hole locations for the #10 screw (#21 bit). **⚠ Drill the Removal-Tamper screw location for the #6 screw (#35 bit).** Hold the switch module in position: Drive each screw in until seated, securing the device.

⚠ CAUTION: Magnasphere's magnet module and anti-removal magnet are extremely powerful: Take precautions to avoid the magnetic attraction between the magnet and ferrous metals (or other magnets). Align the magnet module directly below the switch module. Determine whether spacers are needed to achieve mounted alignment of the modules. Hold the magnet module and any necessary spacers in position. Drill the 4 hole locations for #10 screws (#21 bit). Drive each screw in location until each has seated, securing the device.

Insert the Removal-Tamper magnet and then the Removal-Tamper plug into the 3/8" hole at the face of the switch module. Check the gap between modules. The mechanical installation of the set is complete.

(continued) egress door instructions:

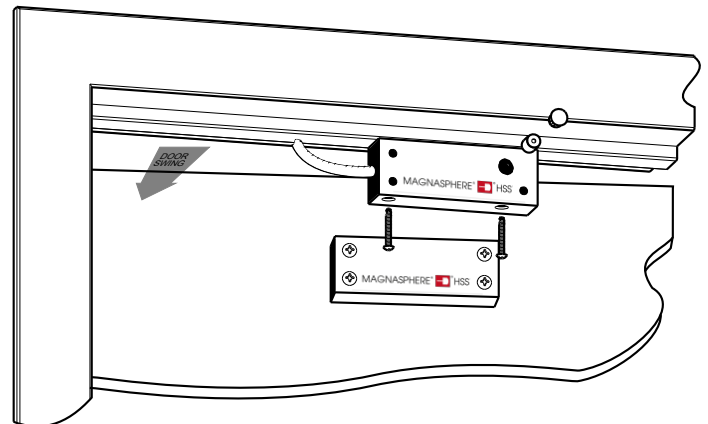

Mark & pilot-drill all hole locations. The single clearance hole for the anti-rotational screw must now be drilled to 3/16" or 7/32" diameter. Drill the 2 mounting hole locations for the #6 screw (#35 bit). Hold the switch module in position: Drive each screw in until seated, securing the device.

⚠ CAUTION: Magnasphere's magnet module and anti-removal magnet are extremely powerful: Take precautions to avoid the magnetic attraction between the magnet and ferrous metals (or other magnets). Align the magnet module directly below the switch module. Determine whether spacers are needed to achieve mounted alignment of the modules. Hold the magnet module and any necessary spacers in position. Drill the 4 hole locations for #10 screws (#21 bit). Drive each screw in location until each has seated, securing the device.

Insert the Removal-Tamper magnet and then the Removal-Tamper plug into the 3/8" hole at the face of the switch module. Check the gap between modules. The mechanical installation of the set is complete.

**Recommended placement to meet door opening and alarm requirements of UL634 Level 2. This guide is one means to meet this standard. Installations which fulfill its requirements are not restricted to the specific recommendations in this instruction set.

Additional mounting hardware, resistor configurations, cable lengths, and other variants are available.

Patents #6506987, #6803845, #6603378 & #8228191, #8314698, 8648720, and Patents Pending

MAY2019 L2X-0XX-FIRE INST REV0

MAGNASPHERE® 