

Required Tools and Components

Provided by Manufacturer (per module set)

- 1 MSS-3XXC switch module
- 1 MSS-3XXC magnet module

Provided by Installer

- Power drill
- 1" Bit/s*
- Adhesive / RTV †

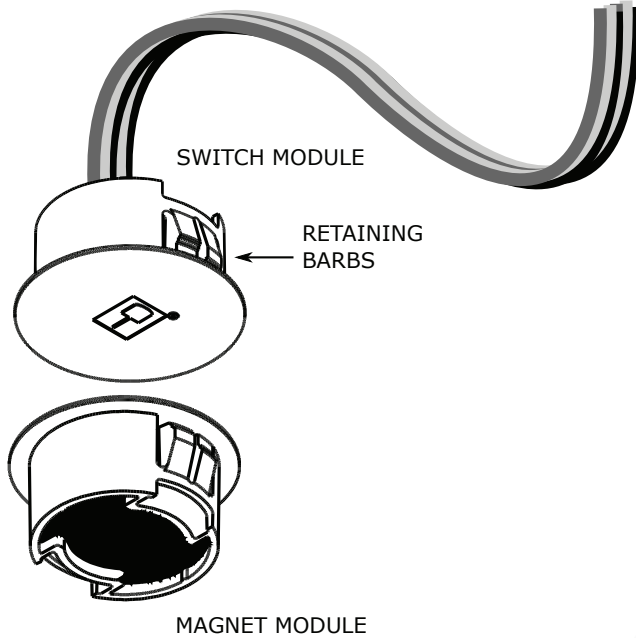

Specifications

Max Current: 0.25 A Resistive
Max Voltage: 30 VDC
Max Power: .25 W Resistive
 The Magnasphere MSS-3XXC series is intended to be connected to a UL Listed compatible control panel for US applications and a ULC Listed compatible control panel for Canadian applications.

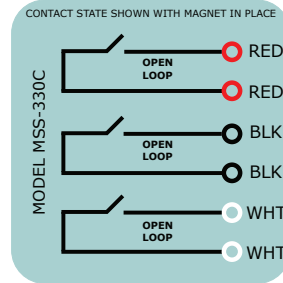
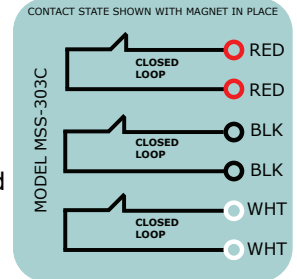

NOMENCLATURE

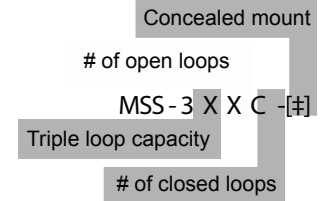

‡ See p.2 for optional embedded resistor schemes

Installation:

The MSS-3XXC should be mounted close to the latch side of the door for optimal performance; Up to 15" (38cm) from the doorknob/door-latch edge is recommended in order to meet UL 681 requirements: contact shall be installed so door cannot be opened more than 2 inches without causing an alarm. Intended for operating gaps of up to 1/4" (6mm). Ensure that the modules are well aligned. In-frame minimum depth clearance should be 5/8" (16mm).

Suitable for outdoor and indoor use, U.S. and Canadian applications.

* Recommended bits: For metal environments, unibits or high quality hole-saws; for wood, Forstner bits (smooth-finish wood-boring drills). Before drilling, a careful layout of the site is recommended in order to achieve module alignment.

Metal burrs from drilling can prevent the retaining barbs of the modules from deploying; remove any troublesome burrs. Wire the switch according to the schematic.

Insert the switch module into the hole in the frame. Insert the magnet module into the hole in the door. † Adhesive (such as RTV) is recommended to assure a secure fit. Adhesive is necessary for materials which are too thick for retaining barb deployment (wood or thick metal). Check the operation of the installed switch.

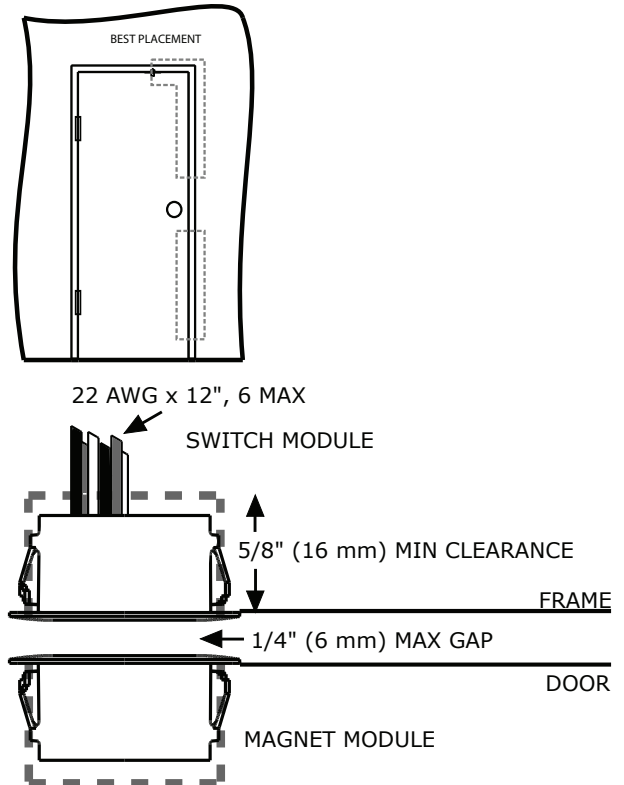

MAGNASPHERE MSS-300C SERIES INSTALLATION INSTRUCTIONS: Base Models and Resistor-Embedded Models of MSS-300C-Series

Schematics: All Base Models

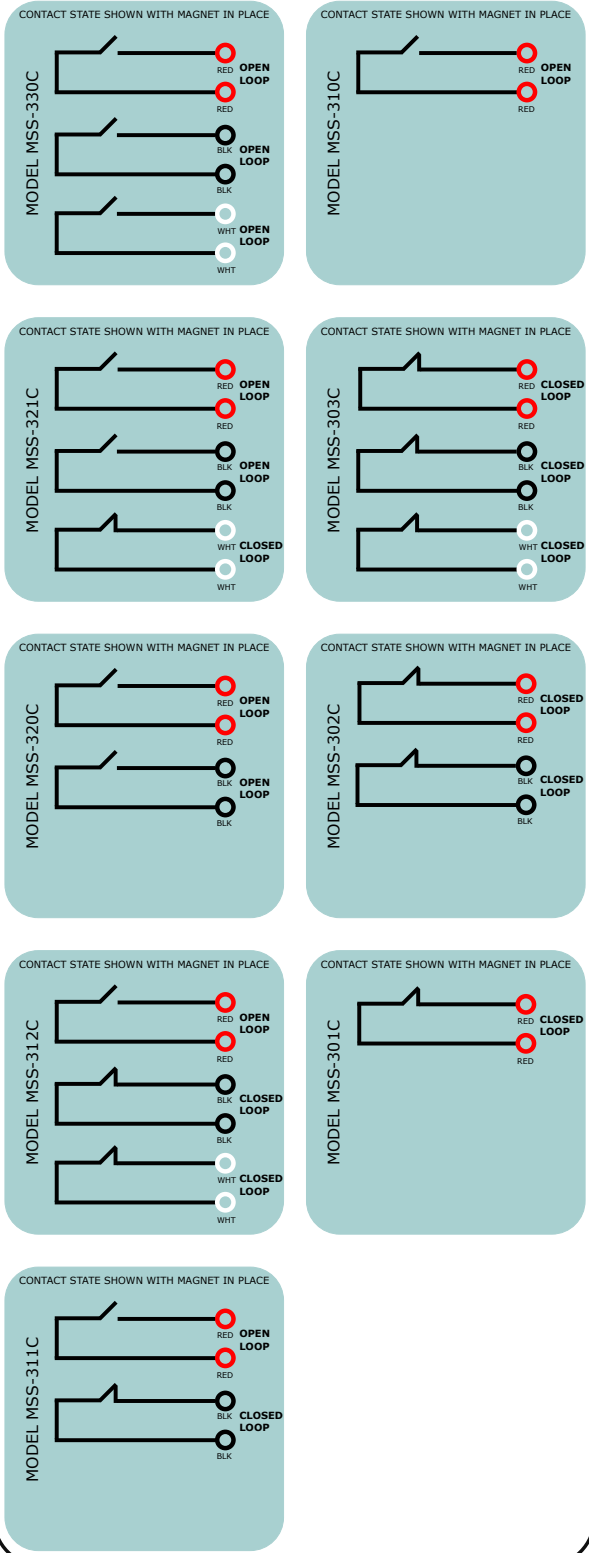

End-Of-Line Resistor Standard Models (### suffix)

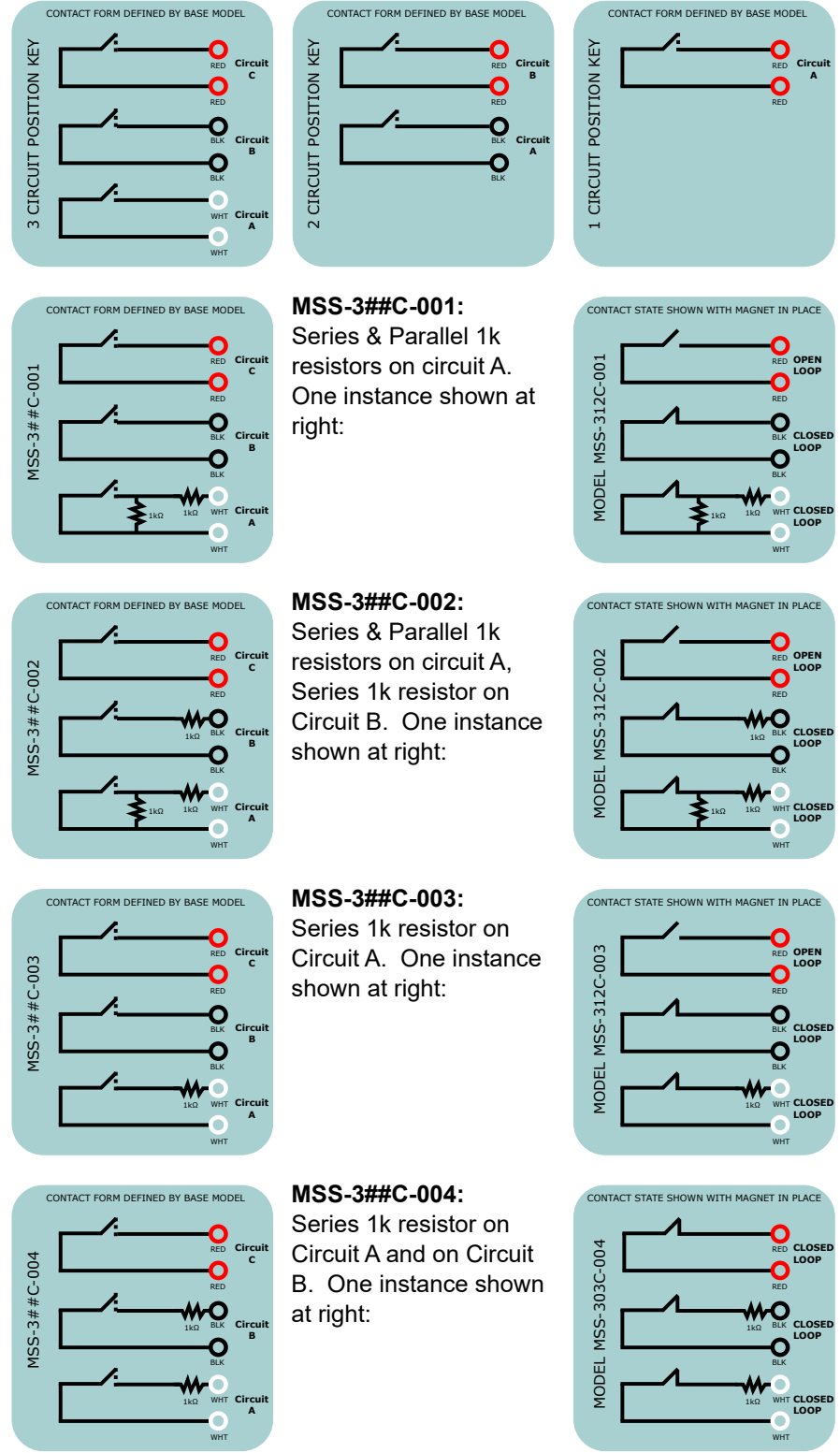

MSS-3##C-001:
Series & Parallel 1k resistors on circuit A. One instance shown at right:

MSS-3##C-002:
Series & Parallel 1k resistors on circuit A, Series 1k resistor on Circuit B. One instance shown at right:

MSS-3##C-003:
Series 1k resistor on Circuit A. One instance shown at right:

MSS-3##C-004:
Series 1k resistor on Circuit A and on Circuit B. One instance shown at right:

End-Of-Line Resistor Custom Models (-i#-#-#-#-# suffix)

i#-#-#-#-# Scheme:
"-i" precedes custom resistor (kΩ) values separated by hyphens. The sequence of entries correlates to the positions depicted in the key. "N" is used as a null place-holder (No resistor for this position). Contact Magnasphere for nomenclature guidance and for resistor value availability.

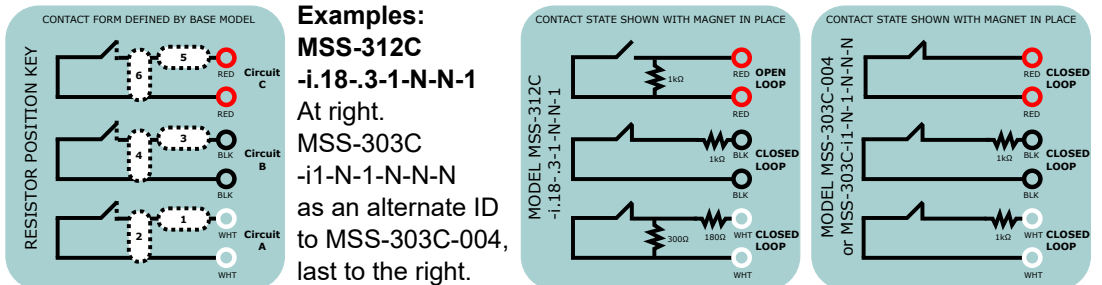

Examples:
MSS-312C -i.18-.3-1-N-N-1
At right.
MSS-303C -i1-N-1-N-N-N
as an alternate ID to MSS-303C-004, last to the right.